

SECTION 9

Knock-Down Doors:

Table of Contents

Leaf and Frame Details

Lock Details

Accessory Details

Installation Instructions

Packaging

Non-Handed Frame

Size: 5 3/4"
Gauge: 16
Color: White

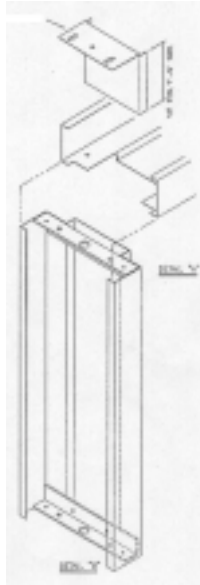

14 gauge girt anchor
 10" length for 7'6" girt height

2" face header

Non-Handed Leaf

Size: 3070/4070
Gauge: 20/18
Color: White

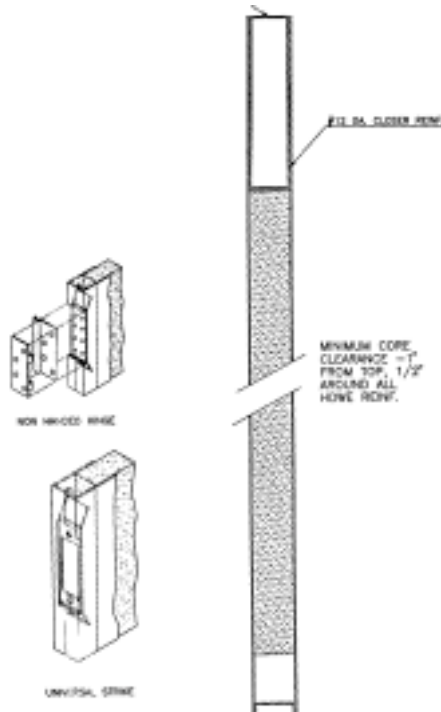

Closed top channel

Continuous laser
 edge weld

Cylindrical Prep

PDQ SE Series – Commercial Lockset

Certifications: ANSI/BHMA A156.2, Series 4000 Grade 2, U.L. Listed.

Keying: 5 pin tumbler with two keys per lock. Standard supply keyed differently.

ADA: Complies with ADA requirements.

Finish: US26D

Warranty: 1 year

Lock Function Entrance Lock

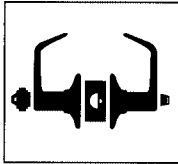

Turn/push-button locking; pushing and turning button locks outside lever requiring use of key until button is manually unlocked. Push-button locking; pushing button locks outside lever until unlocked by key or by turning inside lever.

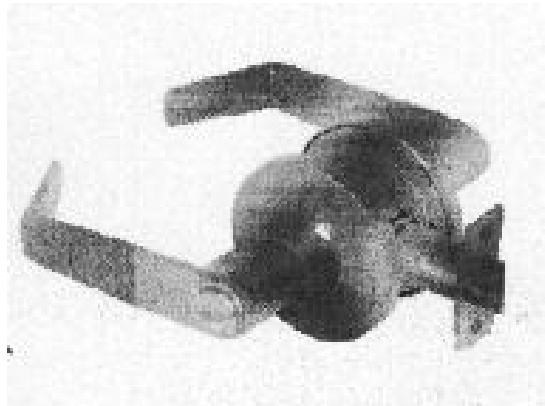

Adhesive Weatherseal

Material: Santoprene

Rating: UL rated

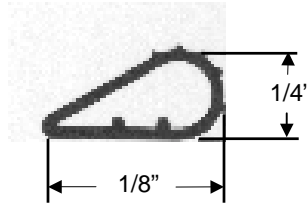

Sweep

Material: Vinyl

Rating: UL rated

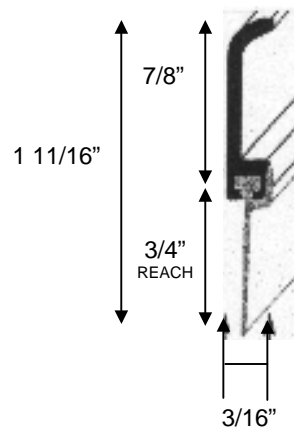

Threshold

Material: Aluminum

Finish: Mill

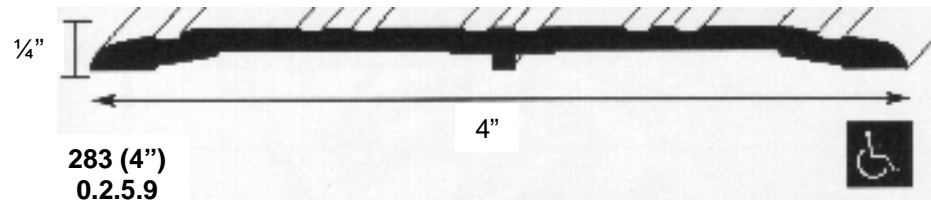

Hinge Detail

Type: Ball-bearing NRP

Size: 4 1/2 x 4 1/2"

Finish: US26D

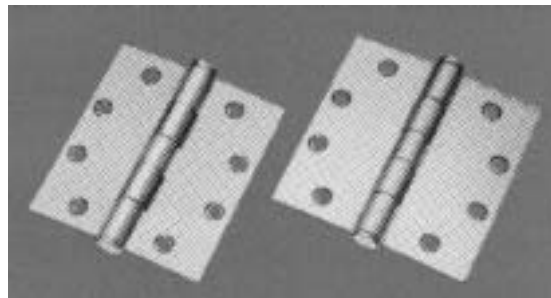

Installation Instructions

Parts List:

- 1 - Hinge Jamb
- 1 - Strike Jam
- 1 - Head
- 2 - Girt Anchors
- 1 - Threshold
- 2 - Threshold Clips
- 1 - Door Leaf
- 1 - Sweep
- 1 - Adhesive Weatherstrip
- 3 - Hinges
- 1 - Lockset

Fasteners:

- 4 - #14 x 1" Hex Head Tek Screws
- 12 - #12 x 3/4" Hex Head Tek Screws
- 2 - #8 x 3/4" Keg Tek Screws
- 4 - 1/2" Sleeve Anchor Bolts
- 3 - Threshold Anchor Bolts

1. Align and assemble frame head, hinge jamb and strike jamb as shown below in Detail A1 and A2:

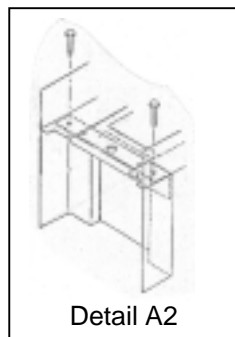
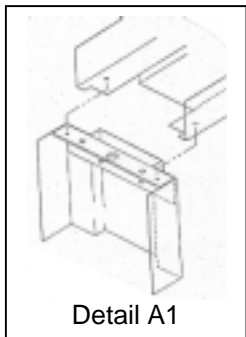

2. Insert but **DO NOT SECURE** girt anchors into the top of the hinge jamb and strike jamb as shown in Detail A3:

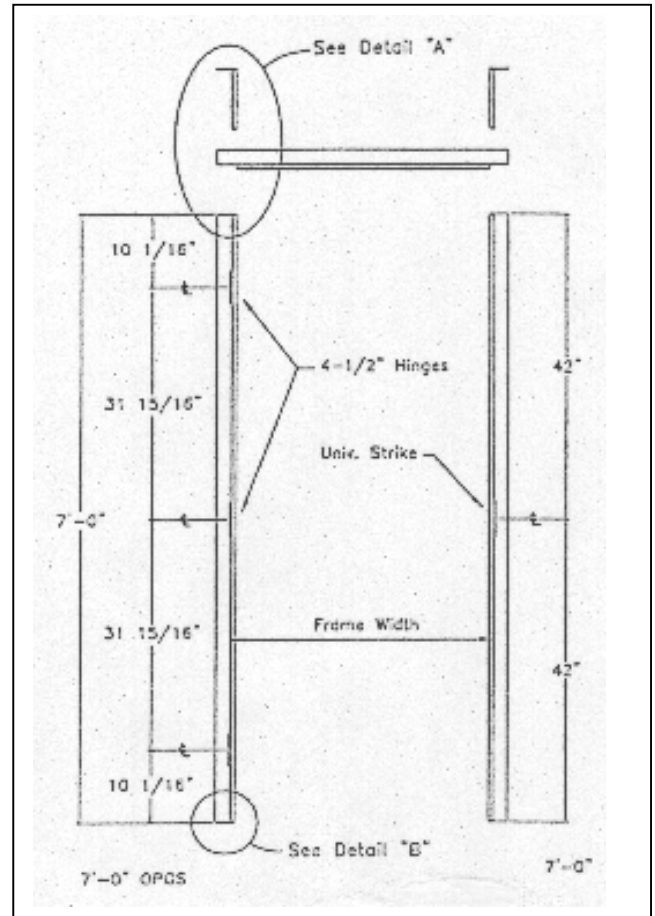
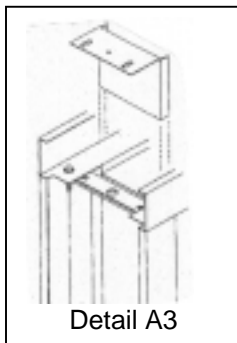

Elevation

(R.H. shown, to make L.H. turn jambs end for end.)

3. Attach threshold clips to threshold and both jambs as shown in Detail B:

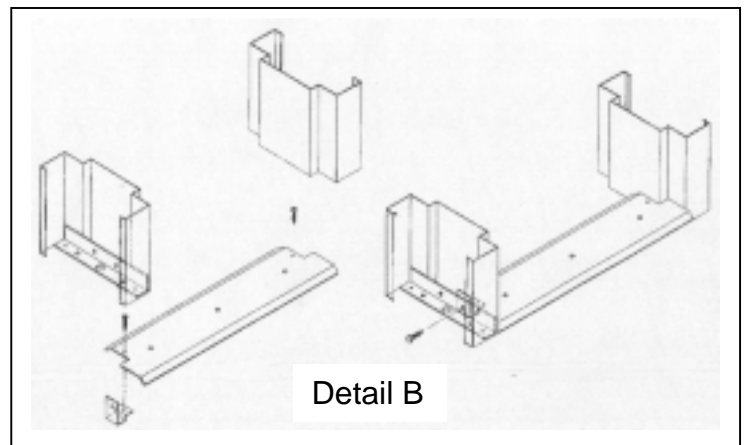

4. Position frame under the girt. The outside edge of the threshold and the faces of the frame should be flush with the outside edge of the concrete floor.
5. Plum and square the frame unit using a carpenter's square in each top corner and a level on the face of each jamb.
6. Secure the hinge jamb girt anchor to the girt with 3 #12 x 3/4" tek screws. **DO NOT** secure the girt anchors to the jambs as yet. This will hold the frame in place while anchoring the jambs.
7. While frame is plum and square, anchor the base of each jamb with the 1/2" sleeve anchors as shown in Detail C:
8. Check plum and square once more then secure the girt anchors to the jambs at the top of each jamb as shown in Detail D:

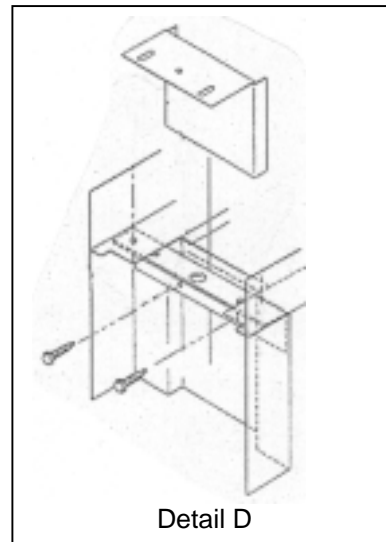
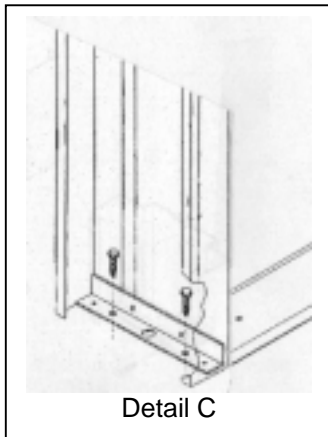

9. Secure threshold to masonry using sleeve anchors provided. Caulk or grout as needed.
10. Install door leaf with hinges and lockset provided. (See installation directions in lock box.)
11. Install weatherstrip to the stops of the head and strike jamb and to the portion of the hinge jamb that the hinges are mortised into adjacent to the stop. (The weatherstrip will cover a portion of the hinge itself.)
12. Install door sweep

For questions regarding this installation call PDL Building Products at 877-735-3667

Knock-Down Packaging

Door leaf, frame and hardware are stacked and wire strapped to a wood pallet

Door leaf: wrapped in water resistant corrugated board

Frame & Hardware: packaged in a water resistant corrugated box

